



Major Ratings and Characteristics

Characteristics	50WQ03FN	Units
$I_{F(AV)}$ Rectangular waveform	5.5	A
V_{RRM}	30	V
I_{FSM} @ $t_p=5\mu s$ sine	320	A
V_F @ 5 Apk, $T_J=125^\circ C$	0.35	V
T_J range	-40 to 150	$^\circ C$

Description/ Features

The 50WQ03FN surface mount Schottky rectifier has been designed for applications requiring low forward drop and small foot prints on PC board. Typical applications are in disk drives, switching power supplies, converters, free-wheeling diodes, battery charging, and reverse battery protection.

- Popular D-PAK outline
- Small foot print, surface moutable
- Low forward voltage drop
- High frequency operation
- Guard ring for enhanced ruggedness and long term reliability

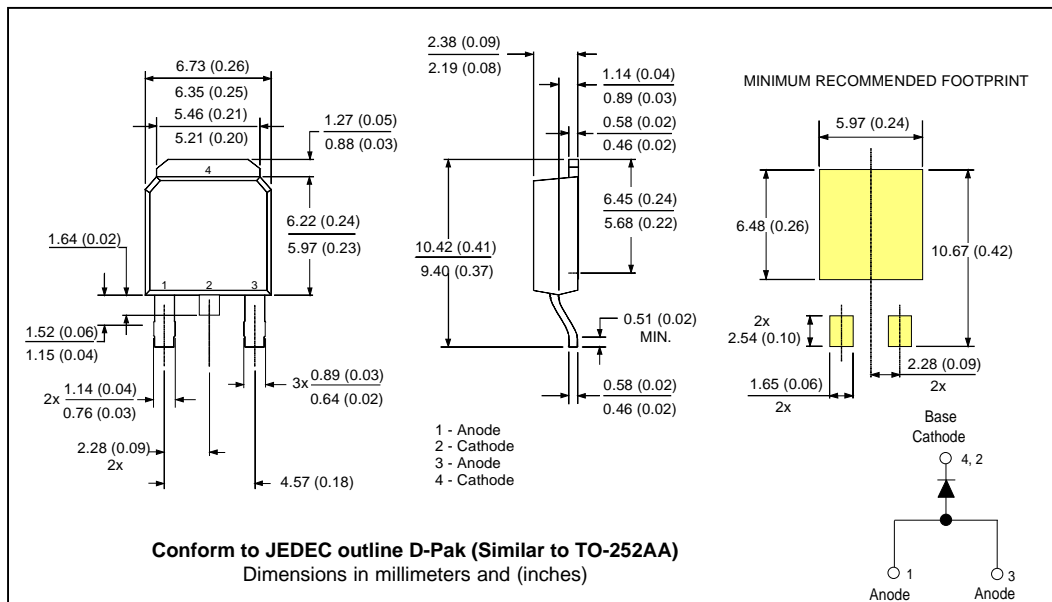

Voltage Ratings

Part number	50WQ03FN
V_R Max. DC Reverse Voltage (V)	30
V_{RWM} Max. Working Peak Reverse Voltage (V)	

Absolute Maximum Ratings

Parameters	50WQ...	Units	Conditions
$I_{F(AV)}$ Max. Average Forward Current * See Fig. 5	5.5	A	50% duty cycle @ $T_C = 136^\circ\text{C}$, rectangular wave form
I_{FSM} Max. Peak One Cycle Non-Repetitive Surge Current * See Fig. 7	320	A	Following any rated load condition and with rated V_{RRM} applied
	130		
E_{AS} Non-Repetitive Avalanche Energy	10	mJ	$T_J = 25^\circ\text{C}$, $I_{AS} = 2.0$ Amps, $L = 5$ mH
I_{AR} Repetitive Avalanche Current	2.0	A	Current decaying linearly to zero in 1 μsec Frequency limited by T_J max. $V_A = 1.5 \times V_R$ typical

Electrical Specifications

Parameters	50WQ...	Units	Conditions
V_{FM} Max. Forward Voltage Drop * See Fig. 1 (1)	0.46	V	@ 5A $T_J = 25^\circ\text{C}$
	0.53	V	@ 10A
	0.35	V	@ 5A $T_J = 125^\circ\text{C}$
	0.46	V	@ 10A
I_{RM} Max. Reverse Leakage Current * See Fig. 2 (1)	3	mA	$T_J = 25^\circ\text{C}$
	58	mA	$T_J = 125^\circ\text{C}$ $V_R = \text{rated } V_R$
$V_{F(TO)}$ Threshold Voltage	0.19	V	$T_J = T_J \text{ max.}$
r_t Forward Slope Resistance	22.22	m Ω	
C_T Typical Junction Capacitance	590	pF	$V_R = 5V_{DC}$, (test signal range 100Khz to 1Mhz) 25°C
L_S Typical Series Inductance	5.0	nH	Measured lead to lead 5mm from package body

(1) Pulse Width < 300 μs , Duty Cycle < 2%

Thermal-Mechanical Specifications

Parameters	50W...	Units	Conditions
T_J Max. Junction Temperature Range (*)	-40 to 150	$^\circ\text{C}$	
T_{stg} Max. Storage Temperature Range	-40 to 150	$^\circ\text{C}$	
R_{thJC} Max. Thermal Resistance Junction to Case	3.0	$^\circ\text{C/W}$	DC operation * See Fig. 4
wt Approximate Weight	0.3 (0.01)	g (oz.)	
Case Style	D - PAK		Similar to TO-252AA

(*) $\frac{dP_{tot}}{dT_J} < \frac{1}{R_{th(j-a)}}$ thermal runaway condition for a diode on its own heatsink

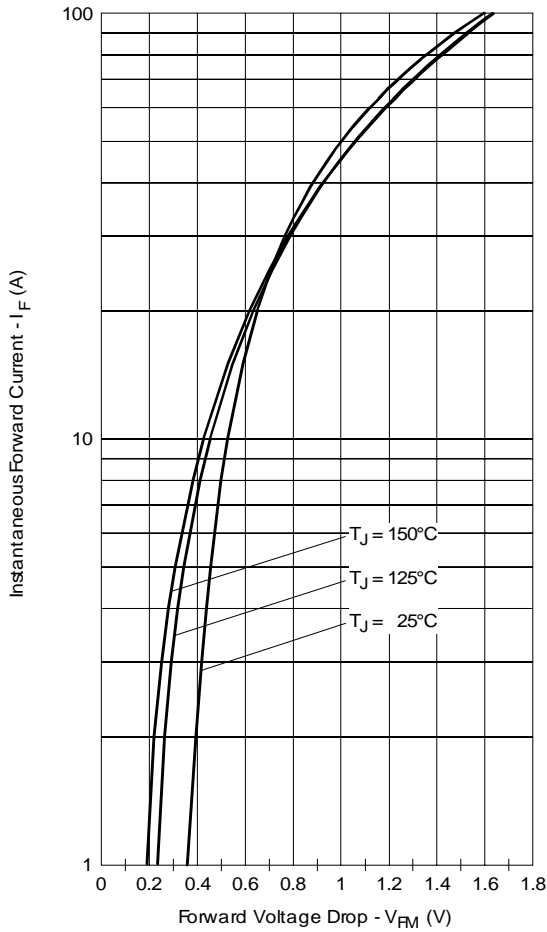

Fig. 1 - Maximum Forward Voltage Drop Characteristics

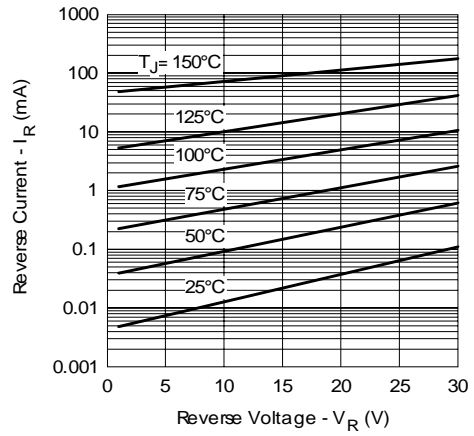

Fig. 2 - Typical Values of Reverse Current Vs. Reverse Voltage

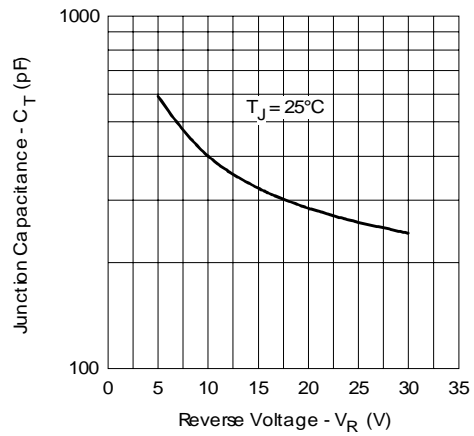

Fig. 3 - Typical Junction Capacitance Vs. Reverse Voltage

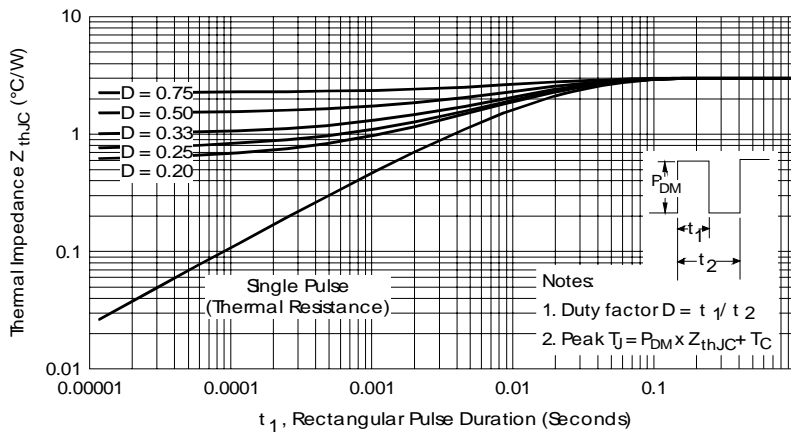

Fig. 4 - Maximum Thermal Impedance Z_{thJC} Characteristics

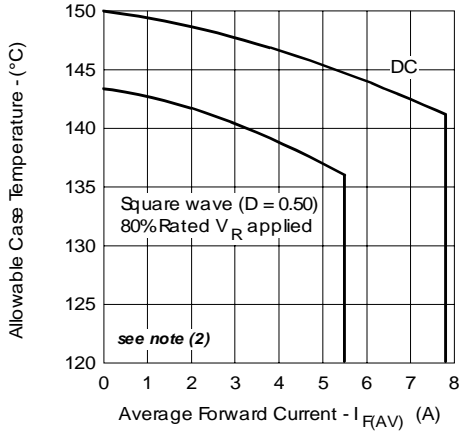

Fig. 5 - Maximum Allowable Case Temperature Vs. Average Forward Current

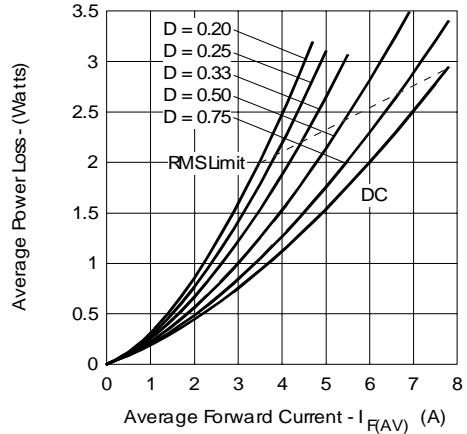

Fig. 6 - Forward Power Loss Characteristics

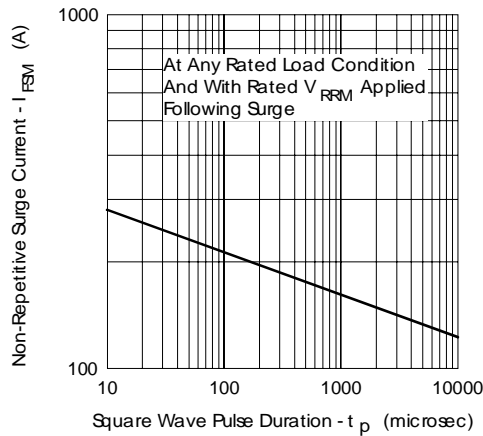

Fig. 7 - Maximum Non-Repetitive Surge Current

(2) Formula used: $T_C = T_J - (Pd + Pd_{REV}) \times R_{thJC}$;

Pd = Forward Power Loss = $I_{F(AV)} \times V_{FM} @ (I_{F(AV)} / D)$ (see Fig. 6);

Pd_{REV} = Inverse Power Loss = $V_{R1} \times I_R (1 - D)$; $I_R @ V_{R1} = 80\%$ rated V_R

Marking Information

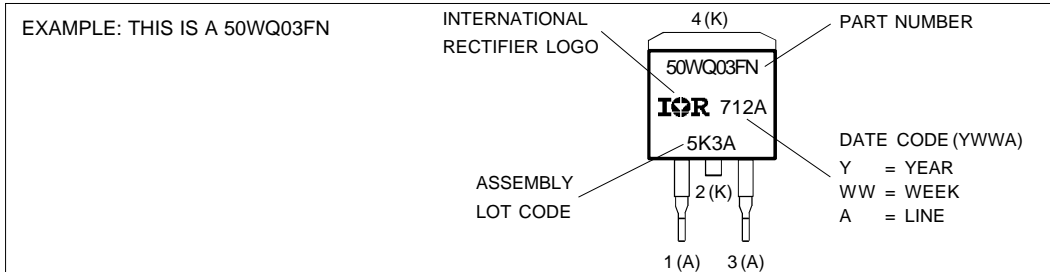

Tape & Reel Information

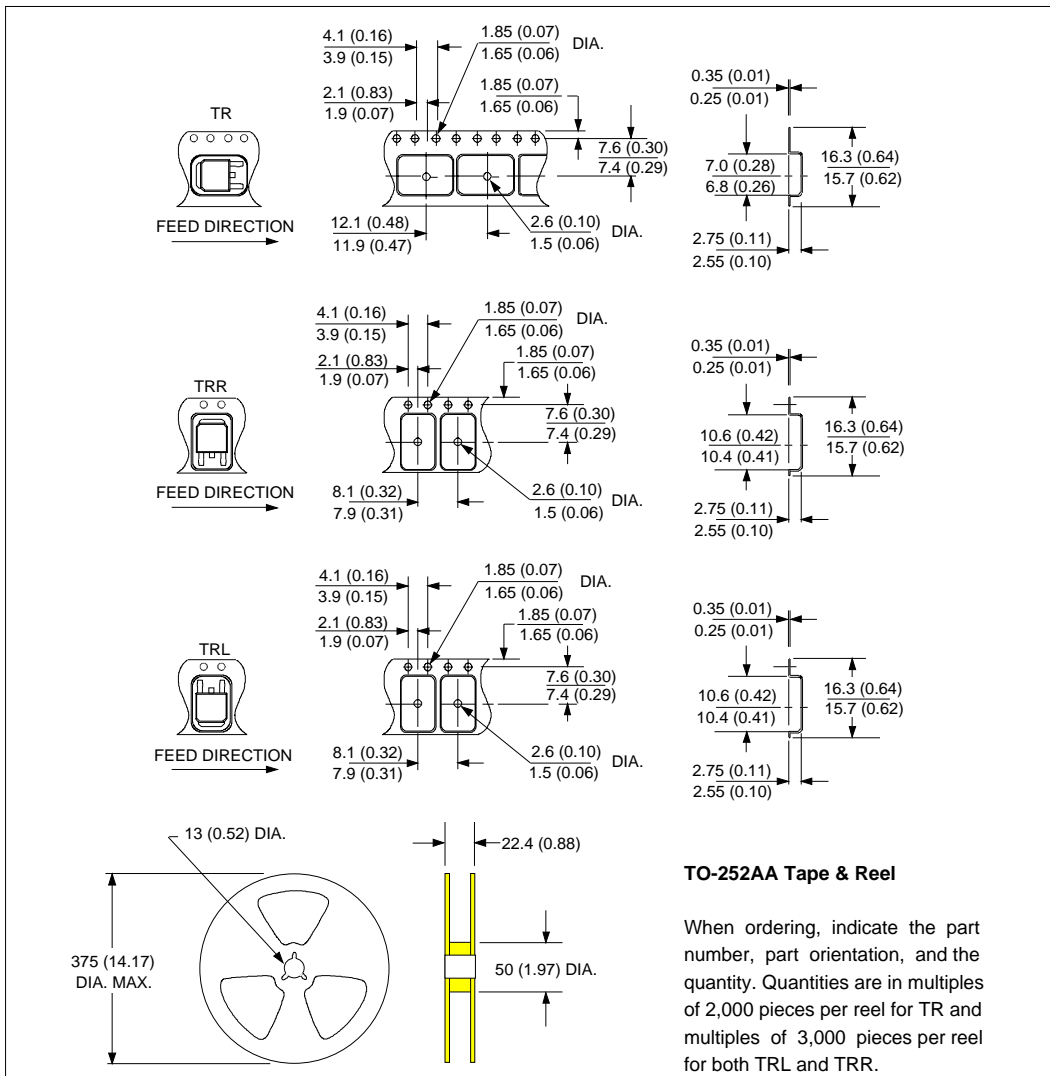

50WQ03FN

Bulletin PD-20551 rev. E 03/03

International
IOR Rectifier

Data and specifications subject to change without notice.
This product has been designed and qualified for Industrial Level.
Qualification Standards can be found on IR's Web site.

International
IOR Rectifier

IR WORLD HEADQUARTERS: 233 Kansas St., El Segundo, California 90245, USA Tel: (310) 252-7105
TAC Fax: (310) 252-7309
Visit us at www.irf.com for sales contact information. 03/03

This datasheet has been download from:

www.datasheetcatalog.com

Datasheets for electronics components.